

# Technical Information

## Ceracore USC30

Process pressure measurement



### Capacitive, ceramic pressure sensor

#### Application

Pressure sensor for use in the pressure measurement of liquid and gaseous media.

#### Your benefits

Dry capacitive ceramic sensor with ultrapure (99.9 %)  $\text{Al}_2\text{O}_3$  ceramic

- High overload resistance
- Very good long-term stability
- High corrosion resistance
- Digital/analog signal output (SPI, UART, U)
- Small physical size
- Measuring ranges from 0 to 0.1 bar (0 to 1.5 psi) to 0 to 100 bar (0 to 1500 psi)
- Optional temperature output, switch output

## Table of contents

<b>About this document</b> .....	<b>3</b>	<b>Ordering information</b> .....	<b>14</b>
Document function .....	3	<b>Disposal</b> .....	<b>14</b>
Symbols used .....	3	<b>Accessories</b> .....	<b>15</b>
<b>Function and system design</b> .....	<b>4</b>	<b>Contact addresses</b> .....	<b>15</b>
Measuring principle .....	4	<b>Explanations and supplementary documentation</b> ..	<b>16</b>
CARMEN .....	4	Terms and abbreviations .....	16
<b>Input</b> .....	<b>5</b>	Turn down calculation .....	17
Measured process variable .....	5	Supplementary documentation .....	17
Measuring range .....	5	CARMEN sensor settings .....	17
<b>Power supply</b> .....	<b>6</b>		
Supply voltage .....	6		
Current consumption .....	6		
Sensor connection .....	6		
<b>Output</b> .....	<b>7</b>		
Output signal .....	7		
Signal range and signal on alarm of voltage output .....	7		
Behavior in the event of an error .....	7		
Dead time, time constant .....	7		
Dynamic behavior .....	8		
Damping .....	8		
Noise filter .....	8		
Switch-on time and Warm-up period .....	8		
<b>Performance characteristics</b> .....	<b>9</b>		
Reference operating conditions .....	9		
Reference accuracy .....	9		
Long-term stability .....	9		
Total Error Band (TEB) .....	9		
Long-term stability .....	11		
<b>Installation</b> .....	<b>11</b>		
Influence of the installation position .....	11		
Installation conditions .....	11		
<b>Process and ambient temperature</b> .....	<b>11</b>		
Process temperature range .....	11		
Ambient temperature range .....	11		
Storage temperature range .....	11		
Climate class .....	11		
Electromagnetic compatibility (EMC) .....	11		
Overvoltage protection .....	11		
Safety notes .....	11		
<b>Mechanical construction</b> .....	<b>12</b>		
Device dimensions .....	12		
Materials .....	13		
<b>Certificates and approvals</b> .....	<b>13</b>		
RoHS .....	13		
Other standards and guidelines .....	13		
Calibration; unit .....	13		



## About this document

### Document function



This document contains all the technical data for the device and provides an overview of the device versions and accessories that can be ordered.

### Symbols used

#### Safety symbols

Symbol	Meaning
 <b>WARNING</b>	<b>WARNING!</b> This symbol alerts you to a dangerous situation. Failure to avoid this situation can result in serious or fatal injury.
 <b>NOTICE</b>	<b>NOTICE!</b> This symbol contains information on procedures and other facts which do not result in personal injury.

#### Symbols for certain types of information

Symbol	Meaning
	<b>Tip</b> Indicates additional information.
	Reference to documentation
	Reference to page

#### Symbols in graphics

Symbol	Meaning
1, 2, 3, ...	Item numbers
A, B, C, ...	Views

## Function and system design

### Measuring principle

A capacitive ceramic sensor element is at the core of the USC30. The basic material is  $(\text{Al}_2\text{O}_3)$ , an ultra-pure (99.9%) aluminum oxide ceramic that is highly resistant to many aggressive gases and liquids. Two cylindrical ceramic components (process isolating diaphragm and ceramic substrate) are hermetically sealed together. In the case of absolute pressure sensors, the reference vacuum of  $3.0 \times 10^{-6}$  mbar that is generated in the production process between the process isolating diaphragm and the ceramic substrate becomes permanent, thereby enabling precise pressure measurement relative to the vacuum. In the case of gauge pressure sensors, the back of the process isolating diaphragm is ventilated, i.e. this sensor measures the gauge pressure relative to the atmospheric pressure.

In electrical terms, the sensor element represents a plate capacitor whose change in capacitance is a measure for the change in pressure. The capacitive measurement method satisfies the highest requirements with regard to resolution and reproducibility. Together with the hysteresis-free behavior of the  $\text{Al}_2\text{O}_3$  material, it forms the basis for the excellent technical specifications of the pressure sensor. Furthermore, the sensor element is a dry measuring cell, i.e. there is no separating diaphragm or oil filling which could influence the measurement. Another advantage of the capacitive ceramic sensor is its high overload resistance.

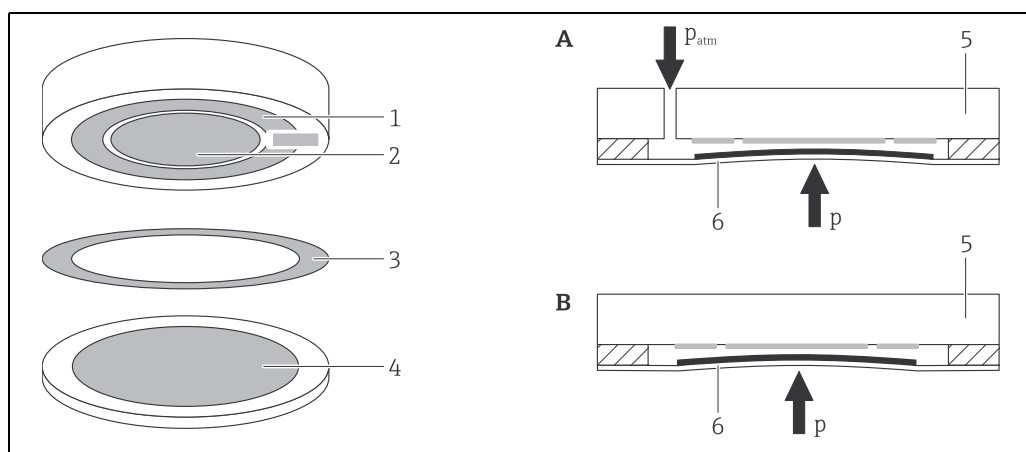

- A Gauge pressure cell  
 B Absolute pressure cell  
 1 Cr electrode  
 2 Cp electrode  
 3 Brazing ring preform  
 4 Counterelectrode  
 5 Ceramic substrate  
 6 Process isolating diaphragm  
 p Process pressure  
 p<sub>atm</sub> Atmospheric pressure

### CARMEN

The CARMEN ASIC is used in sensor applications to measure physical variables (e.g. pressure) with external capacitive or resistive sensors in industrial environments.

Each sensor has its individual properties. CARMEN compensates for these physical properties individually. To do so, CARMEN performs the following steps:

- Measurement of the external sensor (capacitance difference, voltage difference, temperature)
- Compensation of the sensor offset
- Gain adjustment
- Linearization of the sensor characteristics
- Compensation of temperature effects
- Output of the corrected and compensated measured values
- Additional functions (damping, filtering, etc.)

For the standard settings of the sensor, → 17.

The functionality and communication are explained in the S&C CARMEN Manual.

# Input

**Measured process variable**

- Gauge pressure or absolute pressure
- Temperature

## Measuring range

Sensor [bar (psi)]	Maximum sensor measuring range		Lowest calibratable span [bar (psi)]	MWP [bar (psi)]	OPL [bar (psi)]	Vacuum resistance [bar <sub>abs</sub> (psi <sub>abs</sub> )]
	lower (LRL) [bar (psi)]	upper (URL) [bar (psi)]				
<b>Sensors for gauge pressure measurement</b>						
0.1 (1.5)	-0.1 (-1.5)	+0.1 (+1.5)	0.02 (0.3)	2.7 (40.5)	4 (60)	0.7 (10.5)
0.2 (3)	-0.2 (-3)	+0.2 (+3)	0.04 (0.6)	3.3 (49.5)	5 (75)	0
0.4 (6)	-0.4 (-6)	+0.4 (+6)	0.08 (1.2)	4 (60)	6 (90)	0
1 (15)	-1 (-15)	+1 (+15)	0.2 (3)	6.7 (100.5)	10 (150)	0
2 (30)	-1 (-15)	+2 (+30)	0.4 (6)	12 (180)	18 (270)	0
4 (60)	-1 (-15)	+4 (+60)	0.8 (12)	16.7 (250.5)	25 (375)	0
10 (150)	-1 (-15)	+10 (+150)	2 (30)	26.7 (400.5)	40 (600)	0
20 (300)	-1 (-15)	+20 (+300)	4 (60)	26.7 (400.5)	40 (600)	0
40 (600)	-1 (-15)	+40 (+600)	8 (120)	40 (600)	60 (900)	0
100 (1500)	-1 (-15)	+100 (+1500)	20 (300)	100 (1500)	150 (2250)	0
<b>Sensors for absolute pressure measurement</b>						
0.1 (1.5)	0	+0.1 (+1.5)	0.02 (0.3)	2.7 (40.5)	4 (60)	0
0.2 (3)	0	+0.2 (+3)	0.04 (0.6)	3.3 (49.5)	5 (75)	0
0.4 (6)	0	+0.4 (+6)	0.08 (1.2)	4 (60)	6 (90)	0
1 (15)	0	+1 (+15)	0.2 (3)	6.7 (100.5)	10 (150)	0
2 (30)	0	+2 (+30)	0.4 (6)	12 (180)	18 (270)	0
4 (60)	0	+4 (+60)	0.8 (12)	16.7 (250.5)	25 (375)	0
10 (150)	0	+10 (+150)	2 (30)	26.7 (400.5)	40 (600)	0
20 (300)	0	+20 (+300)	4 (60)	26.7 (400.5)	40 (600)	0
40 (600)	0	+40 (+600)	8 (120)	40 (600)	60 (900)	0
100 (1500)	0	+100 (+1500)	20 (300)	100 (1500)	150 (2250)	0

### **▲ WARNING**

**The maximum pressure for the measuring device depends on the lowest-rated element with regard to pressure.**

- ▶ The measuring device must be operated only within the specified limits!

## Power supply

### Supply voltage

Type	Value
Digital output, Analog output	2.9 ... 5.5 V DC

### Current consumption

< 1.6 mA

### Sensor connection

#### NOTICE

**Incorrect polarity can damage the ASIC!**

- ▶ Ensure polarity is correct.

#### NOTICE

**Incorrect analog measured value due to cable break from GND!**

- ▶ Prevent cable break from GND.

Female header strip 2x5 pins (1.27 mm (0.05 in) spacing)

- Socket type: SAMTEC SFML-105-02-L-D
- Insertion force (axial only): max. 40 N

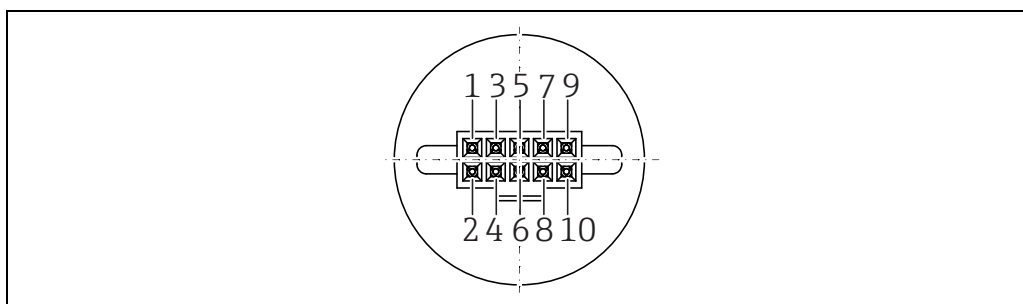

imgdf1\_

PIN	Designation	Explanation	Application		
			Digital		Analog
			UART	SPI	
1	GND	Negative supply voltage	X	X	X
2	RESET_N	Reset (low active)	optional	optional	optional
3	VDD	Positive supply voltage	X	X	X
4	DAC	Analog output (Digital to analog converter)	optional	optional	optional
5	SW_OUT	Switch output (open drain)	optional	optional	optional
6	SPI_SEL	Communication mode selection (UART "GND" or SPI "VDD")	force to "GND"	force to "VDD"	force to "GND"
7	SCK	SPI clock, must be connected to GND if SPI is not used	–	X	–
8	CS_N	Chip select (low active)	optional	optional	–
9	TxD/SO_RDY	Digital communication output	X	X	–
10	RxD/SI	Digital communication input, must be connected to GND if not used	X	X	force to "GND"

# Output

## Output signal

Type	Output
Voltage output (pressure) <sup>1)</sup>	10 to 90 % VDD (ratiometric, VDD = 5.0 V DC)
	10 to 90 % VDDA (absolut, VDDA = 2.65 V DC)
Digital output (pressure & temperature)	SPI
	UART
Switch output (pressure) <sup>2)</sup>	Switch (via CARMEN)

- 1) Max. load: min. 1 MΩ, max. 1 nF
- 2) On request

## Signal range and signal on alarm of voltage output

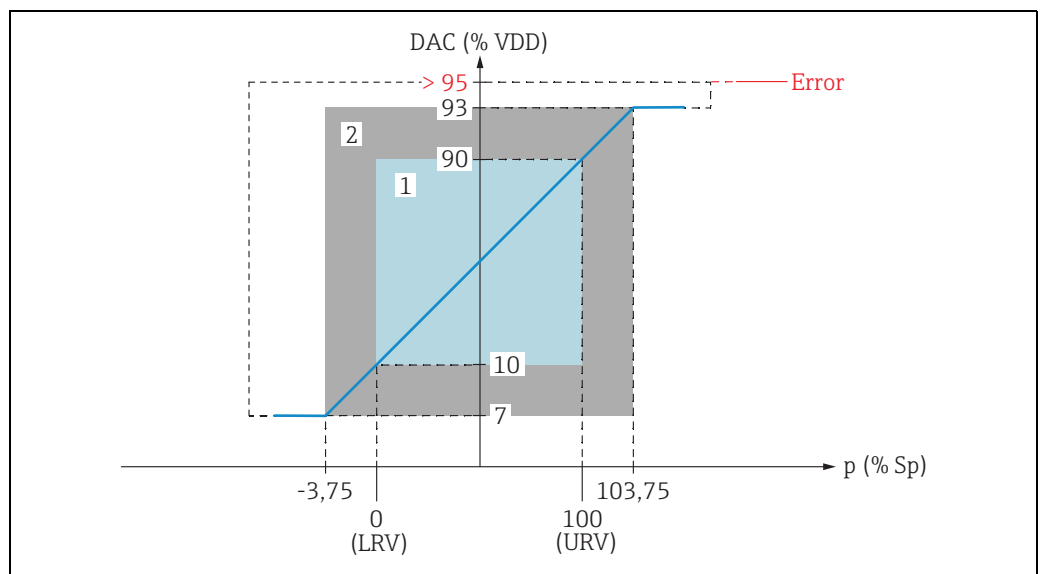

- 1 Calibrated measuring range
- 2 Extended measuring range
- DAC Digital-to-analog converter

The signal range and the signal on alarm are based on NAMUR NE 43. The error value of the signal on alarm can be configured and is displayed in the illustration for the example > 95 % VDD (CARMEN standard sensor setting).

## Behavior in the event of an error

See the S&C CARMEN Manual

## Dead time, time constant

Presentation of the dead time and the time constant:

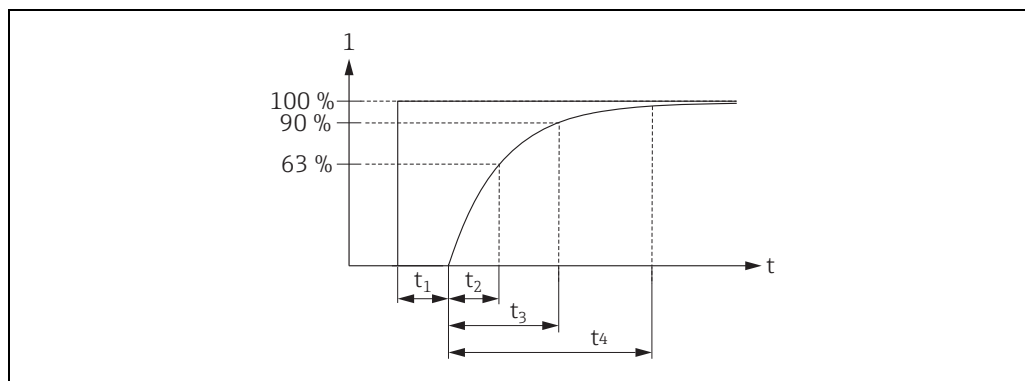

l % of the measured value  
t time

### Dynamic behavior

Output	Sampling rate [ms]	Dead time ( $t_1$ ) [ms]	Time constant T63 ( $t_2$ ) [ms]	Time constant T90 ( $t_3$ ) [ms]	Time constant T99 ( $t_4$ ) [ms]
Digital	20	40	74	88	99
	5	10	18.5	22	25
	1.25 <sup>1)</sup>	3.75	6	7	8
Analog	20	29	63	75	88
	5	8	15.5	19	22
	1.25	2	4.5	6	8.5

- 1) The maximum sampling rate that can be configured for measured value recording is 1.25 ms, but the maximum speed of the digital output is limited to 2.5 ms.

### Damping

Customizable setting: 0 to 40 s

### Noise filter

A noise filter is optionally available as a sensor add-on function (see S&C CARMEN Customer Manual).

### Switch-on time and Warm-up period

The switch-on time is the time that elapses from when the supply voltage is switched on to when the first digital value or initial analog value is available.

The warm-up period is the time that elapses from when the supply voltage is switched on to the first digital measured value or analog value within the specified reference accuracy (e.g. 0.1 % span).

Output	Sampling rate [ms]	Switch-on time [ms]	Warm-up period [ms]
Digital	20	38.75	98.75
	5	23.75	38.75
	1.25	20	23.75
Analog	20	10	50
	5	10	35
	1.25	10	30



## Performance characteristics

### Reference operating conditions

- As per DIN EN IEC 62828
- Ambient temperature  $T_A$  = constant, in range: +23 to +27 °C (+73 to +81 °F)
- Relative humidity  $\phi$  = constant, in range: 5 to 80 % RH.
- Ambient pressure  $p_A$  = constant, in range: 860 to 1 060 mbar (12.47 to 15.37 psi)
- Position of measuring cell = constant, in range: process isolating diaphragm pointing downwards (see also the "Influence of installation position" section → [11](#))
- Analog output supply voltage: 4.9 to 5.1 V DC
- Digital output supply voltage: 2.9 to 5.5 V DC
- Reference installation of Endress+Hauser (Components and Mounting instructions SD02471P)

### Reference accuracy

The reference accuracy includes the terminal-based non-linearity, the non-repeatability and the pressure hysteresis according to [DIN EN IEC 62828-1].

Sensor	Reference accuracy in % of calibrated span
Platinum	$\pm 0.1 \times TD$ for TD <sup>1)</sup> 1:1 to TD 5:1

1) TD = Turn Down, → [17](#).

### Long-term stability

$\leq 0.1$  %/year related to the upper range limit (URL).

### Total Error Band (TEB)

The Total Error Band includes the following influencing factors:

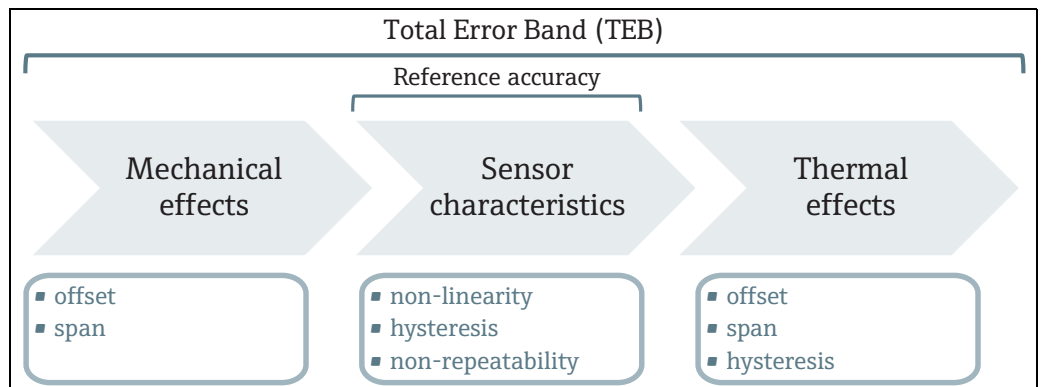

Total\_Error\_Band\_Einflussfaktoren\_EN

**Total Error Band**

- Sensor measuring range: 0.1 to 0.4 bar
- Process temperature: -20 to 80 °C

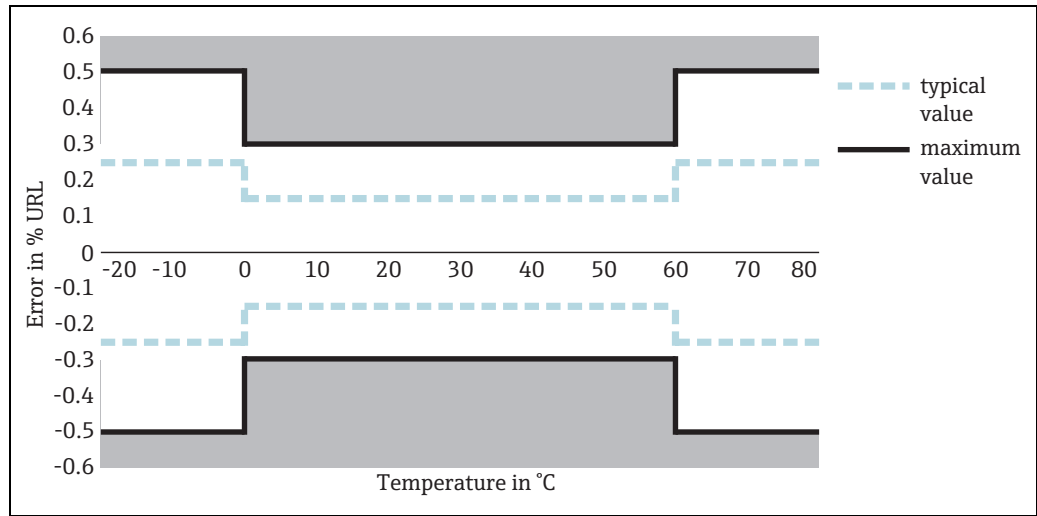

Total\_Error\_Band\_below\_1\_bar\_EN

Temperature range	Error in % of the calibrated span	
	Typ. value	Max. value
0 to +60 °C (+32 to +140 °F)	± 0.15 x TD	± 0.30 x TD
-20 to 0 °C (-4 to +32 °F) +60 to +80 °C (+140 to +176 °F)	± 0.25 x TD	± 0.50 x TD

**Total Error Band**

- Sensor measuring range: 1 to 40 bar
- Process temperature: -20 to 80 °C

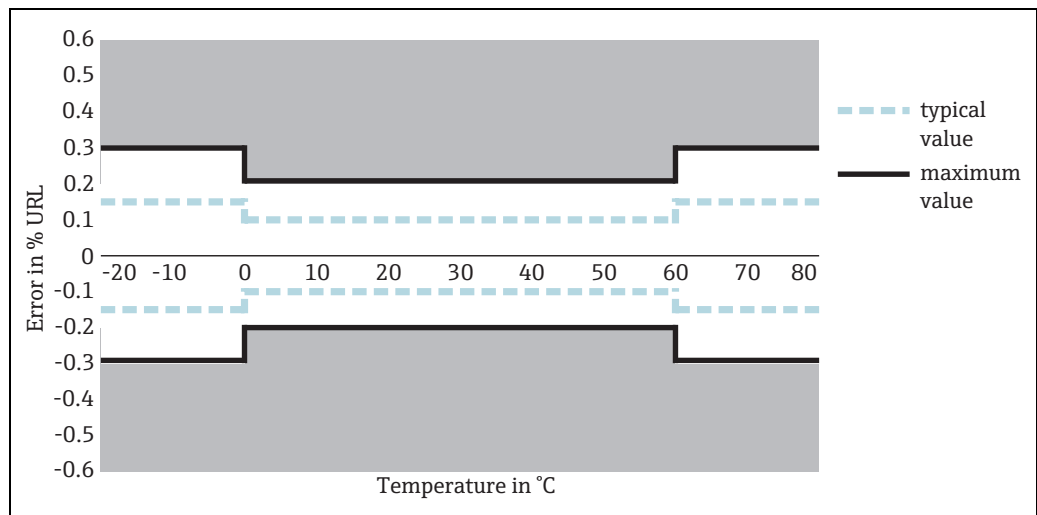

Total\_Error\_Band\_1\_to\_40\_bar\_EN

Temperature range	Error in % of the calibrated span	
	Typ. value	Max. value
0 to +60 °C (+32 to +140 °F)	± 0.10 x TD	± 0.20 x TD
-20 to 0 °C (-4 to +32 °F) +60 to +80 °C (+140 to +176 °F)	± 0.15 x TD	± 0.30 x TD

**Long-term stability** ≤ 0.1 %/year related to the upper range limit (URL).

## Installation

**Influence of the installation position** Any installation position is possible but it may cause a zero point shift.

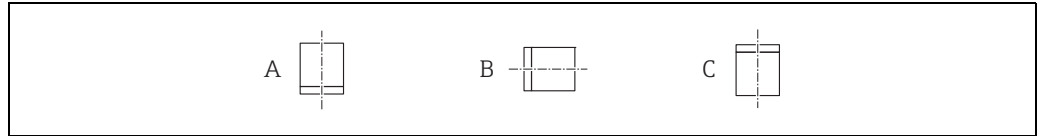

	Process isolating diaphragm pointing downwards (A)	Process isolating diaphragm axis is horizontal (B)	Process isolating diaphragm pointing upwards (C)
<1 bar (15 psi)	Reference position, no effect	Up to +0.1 mbar (0.0015 psi)	Up to +0.2 mbar (0.0030 psi)
≥1 bar (15 psi)	Reference position, no effect	<0.1 mbar (0.0015 psi)	Up to +0.1 mbar (0.0015 psi)

**Installation conditions**

- During installation, electrical connection and operation, no moisture may penetrate the device.
- The back of the sensor element must not be encapsulated.

## Process and ambient temperature

**Process temperature range** -40 to +125 °C (-40 to +257 °F)  
Compensated range -20 to +80 °C (-4 to 176 °F)

**Ambient temperature range** -40 to +125 °C (-40 to +257 °F)  
Compensated range -20 to +80 °C (-4 to 176 °F)

**Storage temperature range** -40 to +125 °C (-40 to +257 °F)

Climate class	System	Climate class	Note
	Open	Class 3K3	Air temperature: 5 to 40 °C (41 to 104 °F), relative humidity: 5 to 85 % satisfied according to 60721-3-3 (condensation not permitted)

**Electromagnetic compatibility (EMC)** No specifications (open system)

**Overvoltage protection** 6 V DC (maximum voltage for CARMEN ASIC)

**Safety notes** For work on and with the device:

**NOTICE**

**Danger of damaging the device**  
Static sensitive devices.

- ▶ Handle only at static safe work stations!



## Mechanical construction

### Device dimensions

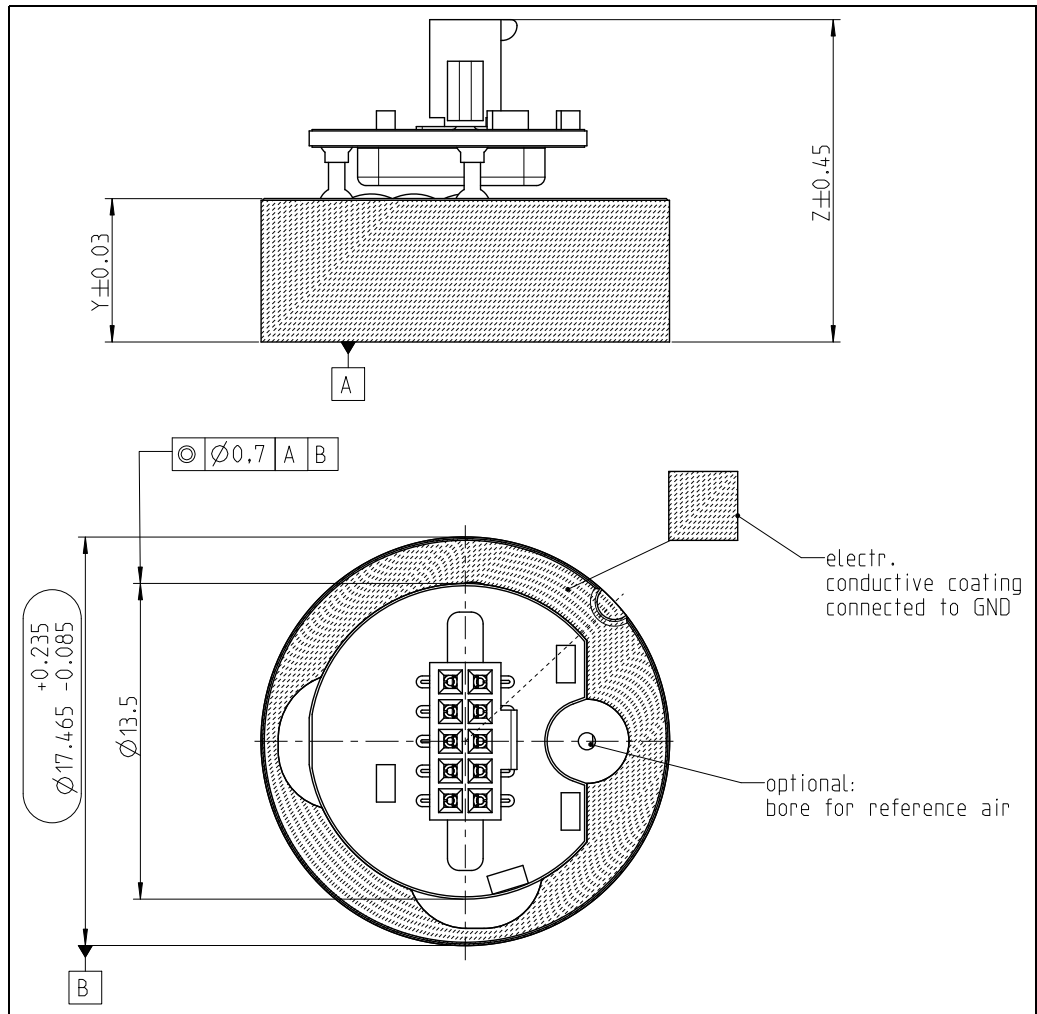

211066831\_EN

Sensor [bar (psi)]	Y [mm]	Z [mm]
0.1 (1.5)	5.13	12.88
0.2 (3)	5.16	12.91
0.4 (6)	5.19	12.94
1 (15)	5.24	12.99
2 (30)	5.3	13.05
4 (60)	5.37	13.12
10 (150)	5.51	13.26
20 (300)	5.63	13.38
40 (600)	5.78	13.53
100 (1500)	6.13	13.88

**Materials**

**Materials in contact with process**

Component part	Material
Process isolating diaphragm	Al <sub>2</sub> O <sub>3</sub> aluminium oxide ceramic FDA, ultra-pure 99.9 % <sup>1)</sup>

- 1) The US Food & Drug Administration (FDA) has no objections to the use of ceramics made of aluminum oxide as a surface material in contact with foodstuffs. This declaration is based on the FDA certificates of our ceramic suppliers.

*TSE free (Transmissible Spongiform Encephalopathy)*

The following applies to all device components in contact with the process:

- They do not contain any materials derived from animals.
- No additives or operating materials derived from animals are used in production or processing.

## Certificates and approvals

**RoHS**

The measuring system complies with the substance restrictions of the Restriction on Hazardous Substances Directive 2011/65/EU.

**Other standards and guidelines**

The applicable European guidelines and standards can be found in the relevant EU Declarations of Conformity. The following were also applied:

**DIN EN IEC 62828-1, 62828-2:**

Reference conditions and procedures for testing industrial and process measurement transmitters  
 Part 1: General procedures for all types of transmitters  
 Part 2: Specific procedures for pressure transmitters

**DIN 16086:**

Electrical pressure measuring instruments, pressure sensors, pressure transmitters, pressure measuring instruments, concepts, specifications on data sheets.  
 Procedure for writing specifications in data sheets for electrical pressure measuring instruments, pressure sensors and pressure transmitters.

**EN 61010-1 (IEC 61010-1):**

Protection Measures for Electrical Equipment for Measurement, Control, Regulation and Laboratory Equipment

**Calibration; unit**

Designation
Nominal range; mbar
Nominal range; bar
Nominal range; psi
Nominal range; Pa
Nominal range; kPa
Nominal range; MPa
Nominal range; mmH <sub>2</sub> O
Nominal range; mH <sub>2</sub> O
Nominal range; inH <sub>2</sub> O
Nominal range; ftH <sub>2</sub> O
Nominal range; mmHg

---

## Ordering information

---

Detailed ordering information is available from the following sources:

In the Product Configurator on the Endress+Hauser website:

[www.sensors-components.endress.com](http://www.sensors-components.endress.com)



### **Product Configurator - the tool for individual product configuration**

- Product-specific configuration data
- Depending on the device: direct input of information specific to measuring point, such as measuring range
- Automatic verification of exclusion criteria

---

## Disposal

---



According to the Directive 2012/19/EU on waste electrical and electronic equipment (WEEE), our products are marked with the depicted symbol in order to minimize the disposal of WEEE as unsorted municipal waste. Such products may not be disposed of as unsorted municipal waste and can be returned to Endress+Hauser for disposal at conditions stipulated in our General Terms and Conditions or as individually agreed.

## Accessories

Designation	Type	Notes	Process temperature range
Installation components	L-ring	See mounting instructions SD02471P position 1	-40 to +80 °C (-40 to +176 °F)
	PTFE foil	See mounting instructions SD02471P position 4	-40 to +125 °C (-40 to +257 °F)
	Ceramic ring	See mounting instructions SD02471P position 5	-40 to +125 °C (-40 to +257 °F)
	Pressure ring	See mounting instructions SD02471P position 6	-40 to +80 °C (-40 to +176 °F)
	Thread ring	See mounting instructions SD02471P position 7	-40 to +125 °C (-40 to +257 °F)
O-ring	FKM	-	-20 to +80 °C (-4 to +176 °F)
	FKM, FDA	FDA21 CFR177.2600 USP Class VI 3A; BAM	0 to +80 °C (+32 to +176 °F)
	EPDM	FDA21 CFR177.2600 USP Class VI (up to +70 °C (+158 °F)) 3A DVGW (W270, W534), WRAS, ACS NSF61	-20 to +80 °C (-4 to +176 °F)
	NBR	-	-20 to +80 °C (-4 to +176 °F)
Cable	Adapter cable for female header strip 2x5 pins (1.27 mm spacing) Mating connector for SAMTEC	-	-10 to +80 °C (+14 to +176 °F)

## Contact addresses

Internet: [www.sensors-components.endress.com](http://www.sensors-components.endress.com)  
 E-mail: [sensors-components.pcm@endress.com](mailto:sensors-components.pcm@endress.com)

## Explanations and supplementary documentation

### Terms and abbreviations

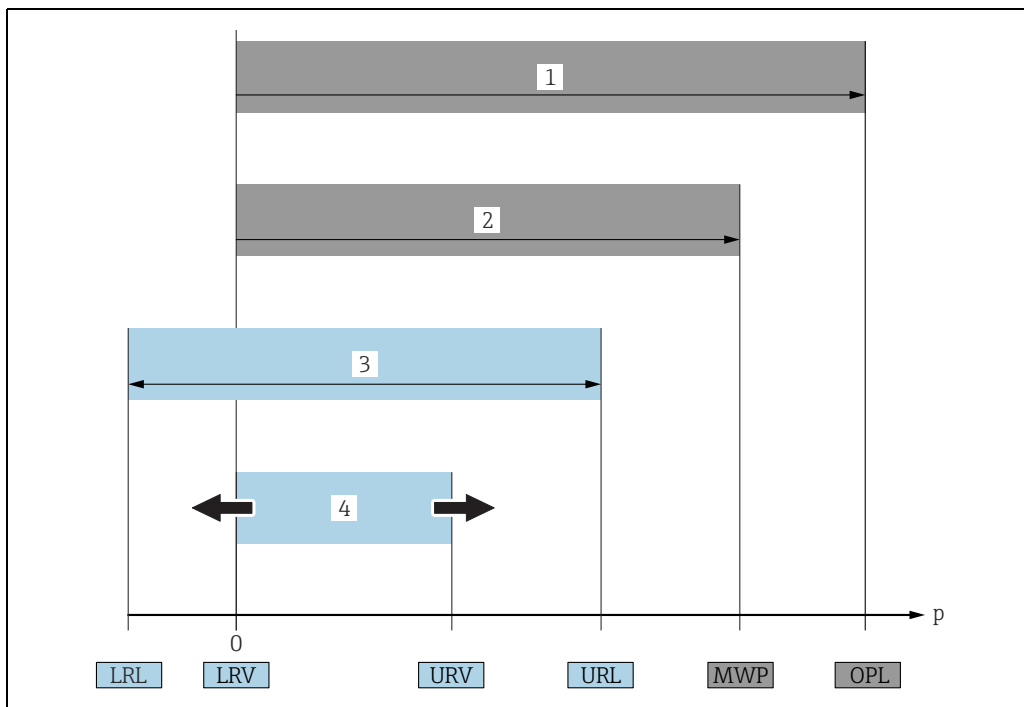

Item	Term/abbreviation	Explanation
1	OPL	The OPL (over pressure limit = sensor overload limit) for the measuring device depends on the lowest-rated element, with regard to pressure, of the selected components, i.e. the process connection has to be taken into consideration in addition to the measuring cell. Also observe pressure-temperature dependency. The test pressure corresponds to the overload limit of the sensor (OPL = 1.5 x MWP) and may only be applied for a limited period of time so that no permanent damage occurs.
2	MWP	The MWP (maximum working pressure) for the sensors depends on the lowest-rated element, with regard to pressure, of the selected components, i.e. the process connection has to be taken into consideration in addition to the measuring cell. Also observe pressure-temperature dependency. The Pressure Equipment Directive (2014/68/EU) uses the abbreviation "PS", which corresponds to the MWP of the measuring instrument. The MWP refers to a reference temperature of +20 °C (+68 °F) and may be applied at the device for an unlimited period.
3	Maximum sensor measuring range	Span between LRL and URL This sensor measuring range is equivalent to the maximum calibratable/adjustable span.
4	Calibrated/adjusted span	Span between LRV and URV Default setting: 0 to URL Other calibrated spans can be ordered as customized spans.
-	p	Pressure
-	LRL	Lower range limit
-	URL	Upper range limit
-	LRV	Lower range value
-	URV	Upper range value
-	TD	Turn Down Example - see the following section.
-	CARMEN	Capacitive And Resistive Measurement <a href="#">ENdress+Hauser</a> → 4
-	Sampling rate	The sampling rate is the integration time for recording the measured value and also the update interval for the output of measured values. Exception: If a sampling rate of 1.25 ms is configured, the integration time is 1.25 ms but the update interval 2.5 ms.
-	ASIC	Application-specific integrated circuit



**Turn down calculation**

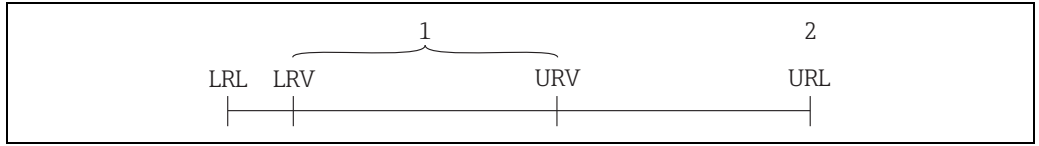

- 1 Calibrated/adjusted span
- 2 Upper range limit

**Example**

- Sensor: 10 bar (150 psi)
- Upper range limit (URL) = 10 bar (150 psi)
- Lower range limit (LRL) = -1 bar (-15 psi)
- Calibrated/adjusted span: 0 to 5 bar (0 to 75 psi)
- Lower range value (LRV) = 0 bar (0 psi)
- Upper range value (URV) = 5 bar (75 psi)

Turn Down (TD):

$$TD = \frac{URL}{|URV - LRV|}$$

$$TD = \frac{10 \text{ bar (150 psi)}}{|5 \text{ bar (75 psi)} - 0 \text{ bar (0 psi)}|} = 2$$

In this example, the TD is 2:1.

For TD < 1, the performance characteristics of TD = 1 apply.

**Supplementary documentation**

- Mounting instructions SD02471P

**CARMEN sensor settings**

Default settings	
Measuring mode	Continuous
Damping	0
Analog initial value	< 5 %
Analog error value	> 95 %
Analog error behavior (status flags)	0, 1, 2, 4, 5, 9, 10, 15, 17, 18
Digital error behavior (status flags)	0, 1, 2, 4, 5, 9, 10, 15, 17, 18
UART baud rate	57.6 kBd
Digital continuous transmission	Activated
Switching threshold, on	0 %
Switching threshold, off	0 %
Switching delay	0 s

The sensor setting is configurable, see S&C CARMEN Customer Manual.







71541326